

PRE RINSES - 'GLOBAL FISHER' SERIES



WALL MOUNT

GLOBAL FISHER
PRE RINSES

| | SPOUT LENGTH | PART NO. | WELS RATING / WATERMARK |
|---|--------------|----------|-------------------------|
| GLOBAL FISHER STANDARD PRE RINSE w/- S/S SINGLE WALL TAP | | | |



| | | |
|-----|----------|---|
| N/A | GF112100 |   |
| | | |
| | | |
| | | |
| | | |

| | | | |
|--|--|--|--|
| GLOBAL FISHER PRE RINSE + ADD ON POT FILLER w/- S/S SINGLE WALL TAP | | | |
|--|--|--|--|



| | | |
|-----|----------|---|
| 6" | GF112506 |    |
| 10" | GF112510 |    |
| 12" | GF112512 |    |
| 14" | GF112514 |    |
| | | |

| | | | |
|---|--|--|--|
| GLOBAL FISHER STANDARD PRE RINSE w/- S/S EXPOSED ADJUSTABLE WALL TAP | | | |
|---|--|--|--|



| | | |
|-----|----------|---|
| N/A | GF152100 |   |
| | | |
| | | |
| | | |
| | | |

| | | | |
|--|--|--|--|
| GLOBAL FISHER PRE RINSE + ADD ON POT FILLER w/- S/S EXPOSED ADJUSTABLE WALL TAP | | | |
|--|--|--|--|



| | | |
|-----|----------|---|
| 6" | GF152506 |    |
| 10" | GF152510 |    |
| 12" | GF152512 |    |
| 14" | GF152514 |    |
| | | |



PRE RINSES – 'GLOBAL FISHER' SERIES

GLOBAL FISHER
PRE RINSES

WALL MOUNT

| | SPOUT LENGTH | PART NO. | WELS RATING / WATERMARK |
|--|--------------|----------|-------------------------|
| <i>GLOBAL FISHER</i> STANDARD PRE RINSE w/- S/S WALL OUTLET ONLY | | | |



| | | |
|-----|----------|---|
| N/A | GF162100 |   |
| | | |
| | | |
| | | |

| | | | |
|---|--|--|--|
| <i>GLOBAL FISHER</i> PRE RINSE + ADD ON POT FILLER w/- S/S WALL OUTLET ONLY | | | |
|---|--|--|--|



| | | |
|-----|----------|---|
| 6" | GF162506 |    |
| 10" | GF162510 |    |
| 12" | GF162512 |    |
| 14" | GF162514 |    |

TECHNICAL DRAWINGS AND INFORMATION

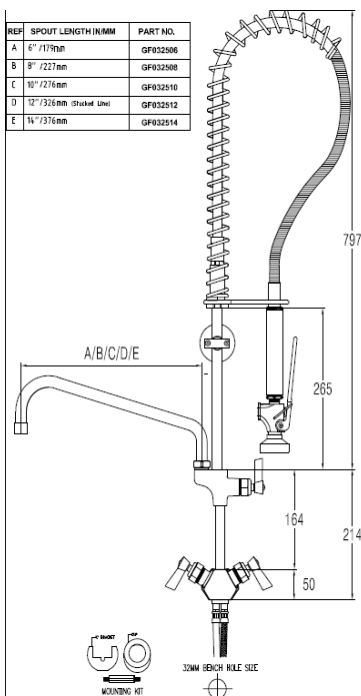

TECHNICAL INFORMATION

- IDEAL WORKING PRESSURE 50-100 PSI
- MAXIMUM PRESSURE = 200 PSI STATIC (in short periods)
- WORKING TEMPERATURE 5 C - 65 C
- SHIPPING WEIGHT – 5.0KG (APPROX)

SUPPLIED WITH-



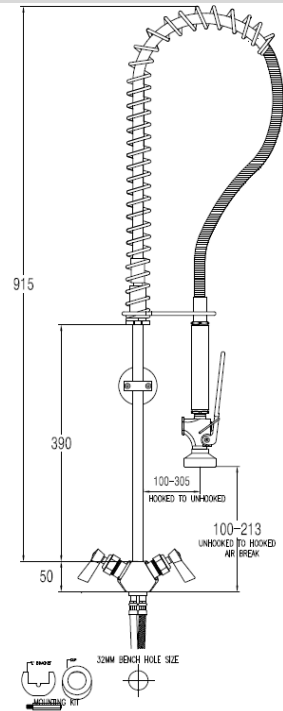



















- CP & / or S/S 16" or 10 1/2" RISER
- S/S ARMOURFLEX HOSE
- S/S TAP BODY
- S/S INLET HOSES AND FITTINGS
- CP SPRAY GUN (3.5LPM) = WELS 6 STAR
- CP WALL BRACKET (adjustable from 50mm – 300mm)
- SPRING LOADED JUMPER VALVES
- CP ADD-ON POT FILLER * (if selected) = WELS 3 STAR



PRE RINSES - 'GLOBAL RINSE MAID' SERIES



HOB / BENCH MOUNT

| | SPOUT LENGTH | PART NO. | WELS RATING / WATERMARK |
|---|--------------|--------------------------|---|
| GLOBAL RINSE MAID SUB ASSEMBLY – STANDARD | | | |
|  | N/A | GRM2100 |   |
| | | <u>Café Model</u> | |
| | | GRM2100-C | |
| | | | |
| GLOBAL RINSE MAID SUB ASSEMBLY + ADD ON POT FILLER | | | |
|  | 6" | GRM2506 |    |
| | 12" | GRM2512 |    |
| | | <u>Café Model</u> | |
| | 6" | GRM2506-C |    |
| | 12" | GRM2512-C |    |
| | | | |
| GLOBAL RINSE MAID STANDARD PRE RINSE w/- CP SINGLE HOB TAP | | | |
|  | N/A | GRM012100 |   |
| | | | |
| | | | |
| | | | |
| GLOBAL RINSE MAID PRE RINSE + ADD ON POT FILLER w/- CP SINGLE HOB TAP | | | |
|  | 12" | GRM012512 |    |
| | | | |
| | | | |
| | | | |









GLOBAL RINSE MAID
PRE RINSES



PRE RINSES – 'GLOBAL RINSE MAID' SERIES

HOB / BENCH MOUNT





GLOBAL RINSE MAID
PRE RINSES

| | SPOUT LENGTH | PART NO. | WELS RATING / WATERMARK |
|--|--------------|-----------|---|
| GLOBAL RINSE MAID STANDARD PRE RINSE w/- CP DUAL HOB TAP | | | |
|  | N/A | GRM032100 |  |
| | | | |
| | | | |
| | | | |
| GLOBAL RINSE MAID PRE RINSE + ADD ON POT FILLER w/- CP DUAL HOB TAP | | | |
|  | 12" | GRM032512 |  |
| | | | |
| | | | |
| | | | |
| | | | |
| GLOBAL RINSE MAID STANDARD PRE RINSE w/- CP EXPOSED ADJUSTABLE HOB TAP | | | |
|  | N/A | GRM052100 |  |
| | | | |
| | | | |
| | | | |
| | | | |
| GLOBAL RINSE MAID PRE RINSE + ADD ON POT FILLER w/- CP EXPOSED ADJUSTABLE HOB TAP | | | |
|  | 12" | GRM052512 |  |
| | | | |
| | | | |
| | | | |
| | | | |

PRE RINSES – 'GLOBAL RINSE MAID' SERIES



HOB / BENCH MOUNT

| | SPOUT LENGTH | PART NO. | WELS RATING / WATERMARK |
|---|--------------|-------------|---|
| GLOBAL RINSE MAID STANDARD PRE RINSE w/- CP HOB MOUNT ONLY | | | |
|  | N/A | GRM062100 |  |
| GLOBAL RINSE MAID PRE RINSE + ADD ON POT FILLER w/- CP HOB MOUNT ONLY | | | |
|  | 12" | GRM062512 |  |
| <u>CAFÉ Model</u> | | | |
| GLOBAL RINSE MAID CAFÉ PRE RINSE w/- S/S DUAL HOB TAP (OVERALL HEIGHT 600MM) | | | |
|  | N/A | GRM032100-C |  |
| GLOBAL RINSE MAID CAFÉ PRE RINSE + ADD ON POT FILLER w/- S/S DUAL HOB TAP (OVERALL HEIGHT 600MM) | | | |
|  | 6" | GRM032506-C |  |
| | 12" | GRM032512-C | |









GLOBAL RINSE MAID
PRE RINSES



PRE RINSES – 'GLOBAL RINSE MAID' SERIES

WALL MOUNT

GLOBAL RINSE MAID
PRE RINSES

| | SPOUT LENGTH | PART NO. | WELS RATING / WATERMARK |
|---|--------------|-----------|---|
| <i>GLOBAL RINSE MAID</i> STANDARD PRE RINSE w/- CP SINGLE WALL TAP | | | |
|  | N/A | GRM112100 |  |
| | | | |
| | | | |
| | | | |
| <i>GLOBAL RINSE MAID</i> PRE RINSE + ADD ON POT FILLER w/- CP SINGLE WALL TAP | | | |
|  | 12" | GRM112512 |  |
| | | | |
| | | | |
| | | | |
| <i>GLOBAL RINSE MAID</i> STANDARD PRE RINSE w/- CP WALL STOPS | | | |
|  | N/A | GRM132100 |  |
| | | | |
| | | | |
| | | | |
| <i>GLOBAL RINSE MAID</i> PRE RINSE + ADD ON POT FILLER w/- CP WALL STOPS | | | |
|  | 12" | GRM132512 |  |
| | | | |
| | | | |
| | | | |